



# ABB i-bus<sup>®</sup> KNX Line Coupler LK/S 4.2 Product Manual



## Contents

Page

<b>1</b>	<b>General .....</b>	<b>3</b>
1.1	Using the product manual.....	3
1.1.1	Structure of the product manual .....	3
1.1.2	Notes .....	4
1.2	Product and functional overview.....	5
1.2.1	Line/area coupler.....	5
1.2.2	Repeater.....	7
<b>2</b>	<b>Device technology .....</b>	<b>9</b>
2.1	Technical data .....	9
2.2	Circuit diagram .....	12
2.3	Dimension drawing .....	13
2.4	Assembly and installation .....	14
2.4.1	Display elements .....	15
<b>3</b>	<b>Commissioning.....</b>	<b>17</b>
3.1	Overview.....	17
3.2	Parameters.....	18
3.2.1	Application for ETS 4.....	18
3.2.1.1	Parameter window <i>General</i> .....	19
3.2.1.2	Device function - <i>Line/Area Coupler</i> .....	20
3.2.1.2.1	Parameter window <i>Main line --&gt; Line</i> .....	20
3.2.1.2.2	Parameter window <i>Line --&gt; Main line</i> .....	23
3.2.1.3	Device function <i>Repeater</i> .....	24
3.2.1.3.1	Parameter window <i>Settings</i> .....	24
3.2.2	Applications for the ETS 3.....	25
3.2.2.1	Application <i>Couple/1.x</i> , parameter window <i>Settings</i> .....	25
3.2.2.2	Application <i>Repeat/1x</i> .....	27
3.2.2.2.1	Parameter window <i>Settings</i> .....	27
<b>A</b>	<b>Appendix .....</b>	<b>29</b>
A.1	Scope of delivery .....	29
A.2	Ordering information.....	30
A.3	Notes .....	31



## 1 General

The ABB i-bus<sup>®</sup> KNX Line Coupler LK/S 4.2 is a modular installation device with a module width of 2 space units. It is used as a line or area coupler or as a repeater. As a line coupler, the LK/S connects a line with a main line, as an area coupler it connects a main line with an area line. It provides electrical isolation in this way.

### 1.1 Using the product manual

This manual provides you with detailed technical information relating to the function, installation and programming of the ABB i-bus<sup>®</sup> KNX Line Coupler. The application of the LK/S is explained using examples.

The manual is divided into the following sections:

- Chapter 1 General
- Chapter 2 Device technology
- Chapter 3 Commissioning
- Chapter A Appendix

#### 1.1.1 Structure of the product manual

Application programs with different ranges of functions can be loaded in the LK/S.

For this reason, all the parameters and functions for ETS 4 and also for ETS 3 are explained in chapter 3.

#### Note

Different application programs are available with the LK/S 4.2 for ETS 3 and ETS 4. Some of the functions for the ETS 4 are not available in the applications for the ETS 3, see [Overview](#), page 17. In ETS 3, there is a separate application for coupling and for repeating (*Couple/1.x* or *Repeat/1.x*), in ETS 4, there is a common application (*Couple Repeat/2.x*).

All applications are upwards compatible, i.e.:

- The old applications of LK/S 4.1 can be loaded in the LK/S 4.2 (ETS 3). This is particularly useful if in an existing project an LK/S 4.1 has to be replaced by an LK/S 4.2.
- The applications *Couple/1.x* or *Repeat/1.x* can be loaded in the LK/S 4.2 via the ETS 3 or the ETS 4.
- The new application *Couple Repeat/2.x* with extended functional range is only available for the ETS 4.

## 1.1.2

### Notes

Notes and safety instructions are represented as follows in this manual:



Note
Tips for usage and operation

Examples
Application examples, installation examples, programming examples

Important
These safety instructions are used as soon as there is danger of a malfunction without risk of damage or injury.

Caution
These safety instructions are used as soon as there is danger of a malfunction without risk of damage or injury.

 Danger
These safety instructions are used if there is a danger for life and limb with inappropriate use.

  Danger
These safety instructions are used if there is a danger to life with inappropriate use.

## 1.2 Product and functional overview

The Line Coupler LK/S 4.2 can be used as a line/area coupler or as a repeater.

### 1.2.1 Line/area coupler

As a line/area coupler, the LK/S connects the data flow of two lines but isolates them electrically.

The coupler can route physically addressed, group addressed as well as broadcast telegrams.

In order to route a physically addressed telegram, the LK/S compares the target address with its own physical address. The physical address of the LK/S determines the line affiliation. The telegrams are routed or not routed depending on the evaluation and parameterization. If the LK/S has not yet received its intended project-assigned physical address, this can cause device faults during commissioning.

The LK/S responds in accordance with its parameterization to telegrams with group addresses.

In order to reduce the telegram traffic, the LK/S only routes telegrams in normal operation (standard settings), whose group addresses have been entered in its filter table. However, it can be useful, particularly during commissioning and for diagnostic purposes, to set the option *route* for both parameters *Group telegrams main group 0...13* and *Group telegrams main group 14...31*, i.e. the filter table is switched off. If the system is fully in operation, both parameters should be reset again to the standard values. The LK/S is then subsequently reprogrammed with the application. Here the correct filter table will be transferred to the LK/S.

Note
The application <i>Couple Repeat/2.x</i> for the ETS 4 filters the main groups 14...31. With the application <i>Couple/1.x</i> , no filter table is calculated by the ETS 3 for the main groups 14...31. For this reason, the main groups 14...31 should not be used. If this is necessary, the parameter <i>Main group 14...31</i> must be set with the option <i>route</i> .

If the LK/S routes a telegram and does not receive an acknowledgement or there is a transmission error, the LK/S repeats the telegram up to three times. With the parameters *In case of errors repeat group telegrams*, the response for both lines is set separately. This parameter should be left as it is in the standard setting.

Normally the LK/S only acknowledges telegrams that it routes. The parameter *Telegram confirmation...* facilitates separate acknowledgement settings for both lines. This parameter should be left as it is in the standard setting.

## Topology

As a line coupler, the LK/S connects a line with a main line. As an area coupler, the LK/S connects a main line with an area line. Each line requires its own power supply.

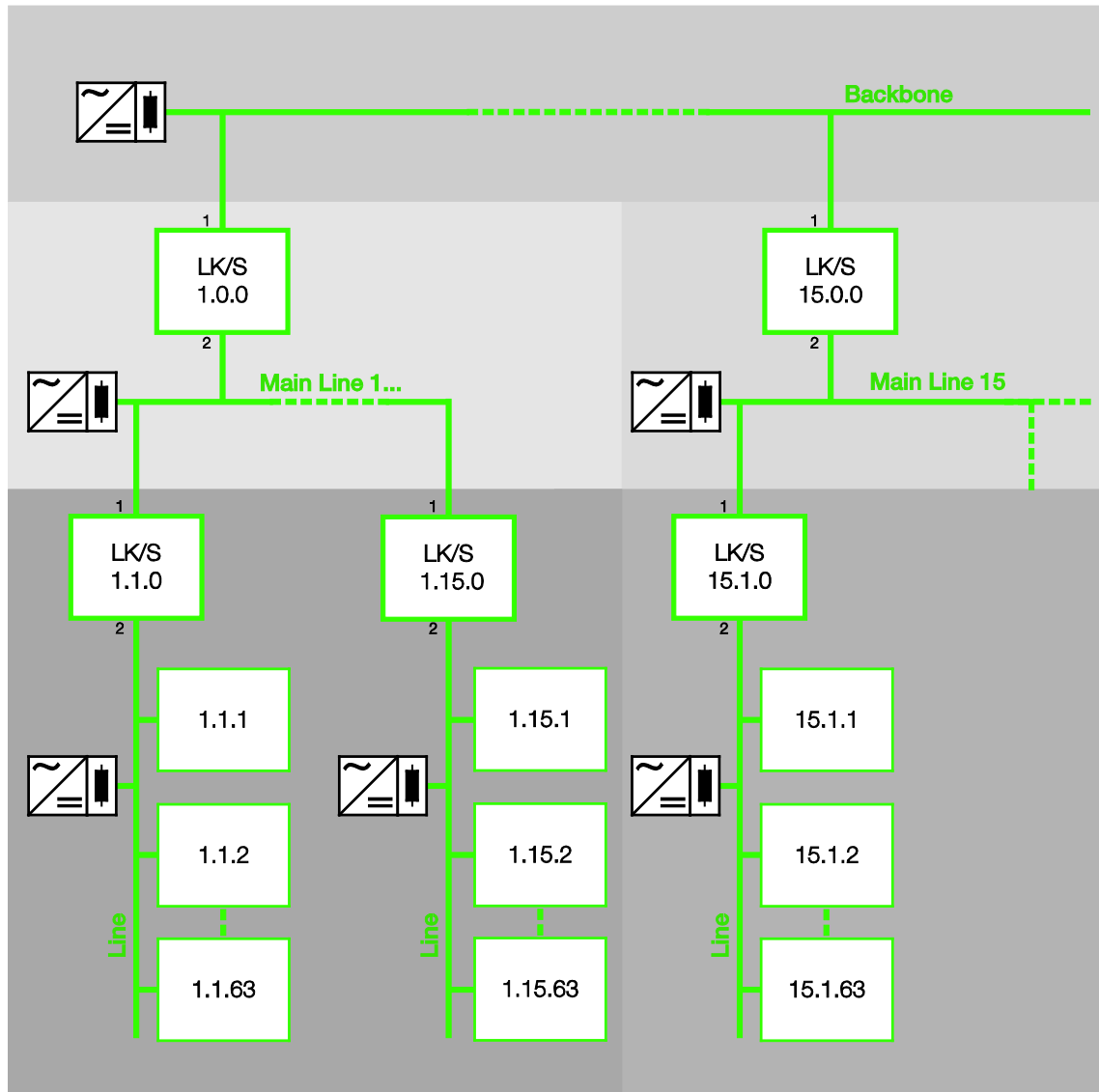

Backbone = Area line with up to 15 area couplers, physical address x.0.0

Main Line = Main line with up to 15 line couplers, physical address x.y.0

Line = Line with up to 64 devices including the line coupler. Up to 256 devices are possible when up to three line repeaters are used.

The function of the device is assigned by the assignment of the physical address.

### Note

If a second output of the Power Supply SV/S is used for connection, a DV/S choke must be connected.  
For further information refer to the Power supply product manual



## 1.2.2

### Repeater

As a repeater, the LK/S connects the data flow of two line segments but isolates them electrically.

Behind a line coupler (in one line), up to three repeaters can be connected in parallel in a line. This is how up to four line segments form an entire line. A line can thus be expanded from 64 possible devices (1 line) up to 256 devices (4 line segments). Every line segment must be provided with power by its own KNX power supply.

The repeaters do not have filter tables. For this reason, a telegram is sent in all line segments independently of whether or not it is processed in the respective line segment. Whether this telegram is initiated within the line or whether it has been sent from the main line via the repeater is also irrelevant.

If there is a transmission error of a physically addressed telegram, this telegram is not repeated.

If the repeater routes a telegram and does not receive an acknowledgement or there is a transmission error, the repeater repeats the telegram up to three times. With the parameters *In case of errors repeat group telegrams*, the response for both line segments is set separately.

## Topology

Up to three repeaters are connected in parallel in a line. Each line segment requires its own power supply.

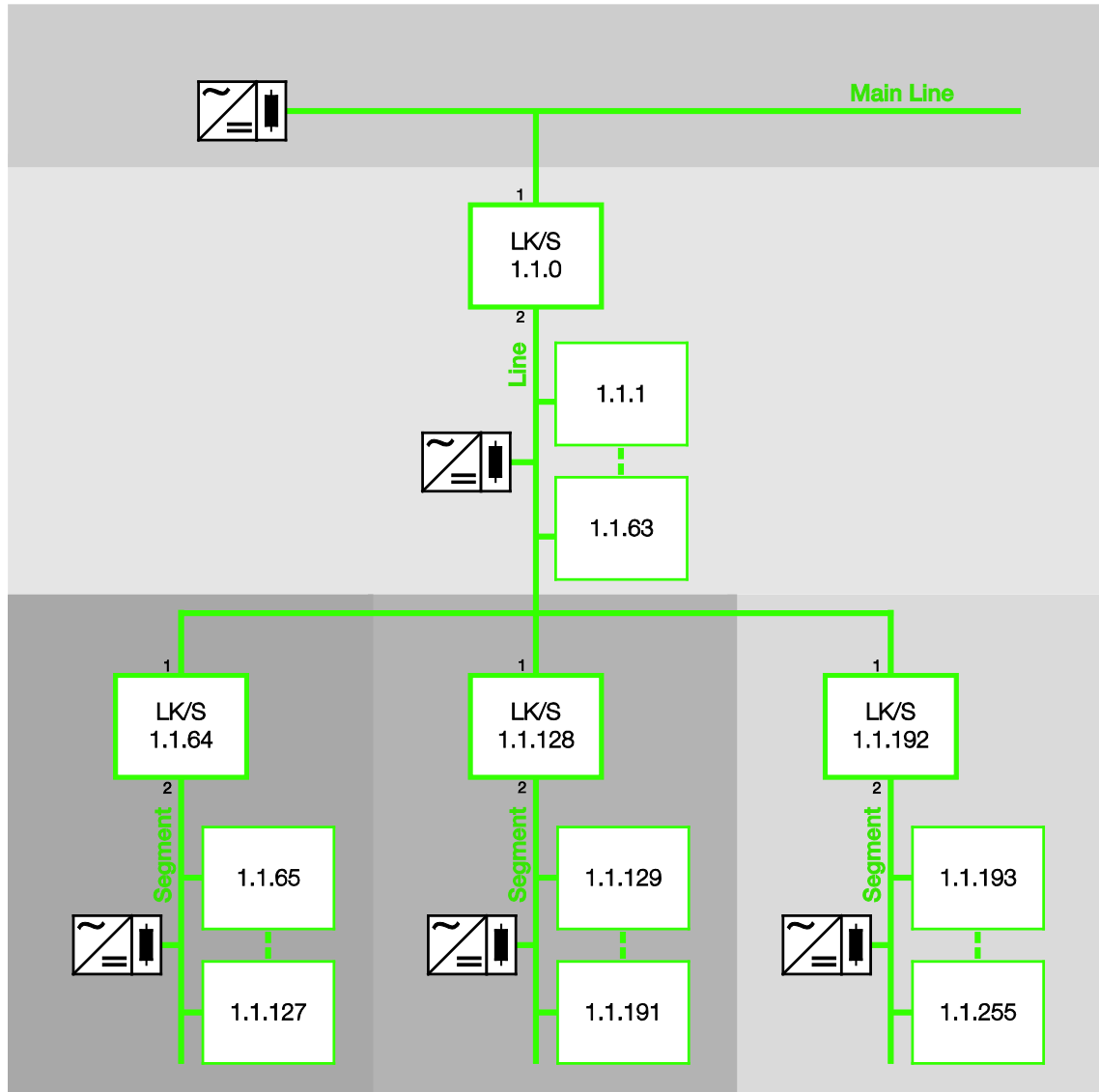

Main Line = Main line with up to 15 line couplers

Line = Line with up to three repeaters

Line Segment = Line segment, per segment up to 64 devices are possible (in total up to 256 devices are possible) including the repeater.

### Note

The topology is not defined with the repeater. Under the coupler 1.1.0, the addresses 1.1.0 to 1.1.255 can be assigned as required to the segments.

# ABB i-bus<sup>®</sup> KNX Device technology





## 2 Device technology



The ABB i-bus<sup>®</sup> KNX Line Coupler LK/S 4.2 is a modular installation device with a module width of 2 space units. It is used as a line or area coupler or as a repeater. As a line coupler, the LK/S connects a line with a main line, as an area coupler it connects a main line with an area line. It provides electrical isolation in this way.

If required, the LK/S filters telegrams and only routes the telegrams intended for other lines. It is possible to route or block all telegrams for diagnostic purposes.

### 2.1 Technical data

<b>Supply</b>	Rated voltage	21...31 V DC, via the bus
	Power consumption	Maximum 0.25 W
	Current consumption	Maximum 12 mA
<b>Connections</b>	KNX, subline (2 = Line)	Via left bus connection terminal
	KNX, subline (1 = Main line)	Via right bus connection terminal
<b>Operating and display elements</b>	Button/LED  (red)	For assignment of the physical address
	LED  <b>ON</b> (green)	For indicating operation
	LED  <b>Main Line</b> (yellow)	For indicating telegram traffic on the main line
	LED  <b>Line</b> (yellow)	For indicating telegram traffic on the sub line
<b>Enclosure</b>	IP 20	To EN 60 529
<b>Safety class</b>	III, in the installed state	To EN 61 140
<b>Insulation category</b>	Overvoltage category	III to EN 60 664-1
	Pollution degree	II to EN 60 664-1
<b>KNX safety extra low voltage</b>	SELV 31 V DC	
<b>EMC requirements</b>	Compliant to EN 61000-6-2, EN 61000-6-3 and EN 50090-2-2	

# ABB i-bus<sup>®</sup> KNX Device technology

<b>Temperature range</b>	Operation	-5 °C...+45 °C
	Storage	-25 °C...+55 °C
	Transport	-25 °C...+70 °C
<b>Ambient conditions</b>	Maximum air humidity	To EN 50 491 95 %, no condensation allowed
<b>Design</b>	Modular installation device (MDRC)	Modular installation device, Pro <i>M</i>
	Dimensions	90 x 36 x 64.5 mm (H x W x D)
	Mounting width	2 modules at 18 mm
	Mounting depth	64.5 mm
<b>Installation</b>	On 35 mm mounting rail	To EN 60 715
<b>Mounting position</b>	As required	
<b>Weight without packaging</b>	0.075 kg	
<b>Housing/colour</b>	Plastic housing, grey	
<b>Approval</b>	EN 60 669-1, EN 50 428	
<b>KNX certification</b>	EN 50 090-2-2, EN 50 491	
<b>CE mark</b>	In accordance with the EMC guideline and low voltage guideline, RoHS	

# ABB i-bus<sup>®</sup> KNX

## Device technology

Device type	Application program	Maximum number of communication objects	Maximum number of group addresses	Maximum number of associations
LK/S 4.2	Couple Repeat/...*	0	0	0
	Couple/...*	0	0	0
	Repeat/...*	0	0	0

\* ... = current version number of the application program.

### Note

The ETS and the current version of the device application program are required for programming. The current application program can be found with the respective software information for download on the Internet at [www.abb.com/knx](http://www.abb.com/knx). After import it is available in the ETS under *ABB/System devices/Couplers*.

The device does not support the locking function of a KNX device in the ETS. If you inhibit access to all devices of the project with a *BCU code*, it has no effect on this device. Data can still be read and programmed.

### Note

Different application programs are available with the LK/S 4.2 for ETS 3 and ETS 4. Some of the functions for the ETS 4 are not available in the applications for the ETS 3, see [Overview](#), page 17. In ETS 3, there is a separate application for coupling and for repeating (*Couple/1.x* or *Repeat/1.x*), in ETS 4, there is a common application (*Couple Repeat/2.x*).

All applications are upwards compatible, i.e.:

- The old applications of LK/S 4.1 can be loaded in the LK/S 4.2 (ETS 3). This is particularly useful if in an existing project an LK/S 4.1 has to be replaced by an LK/S 4.2.
- The applications *Couple/1.x* or *Repeat/1.x* can be loaded in the LK/S 4.2 via the ETS 3 or the ETS 4.
- The new application *Couple Repeat/2.x* with extended functional range is only available for the ETS 4.

## 2.2 Circuit diagram

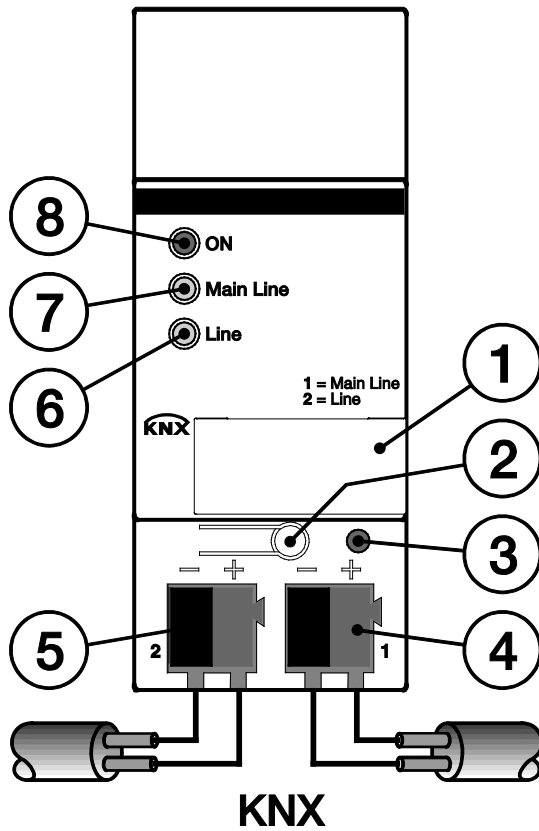

2CDC 072 003 F0012

LK/S

- 1 Label carrier
- 2 Button *Programming* 
- 3 LED *Programming* ● (red)
- 4 Bus connection terminal ABB i-bus<sup>®</sup> KNX of the primary/main line
- 5 Bus connection terminal ABB i-bus<sup>®</sup> KNX of the secondary line
- 6 LED ● *Line* (yellow)
- 7 LED ● *Main Line* (yellow)
- 8 LED ● *ON* (green)

### Note

The main and secondary lines must each be supplied with power from separate power sources (electrically isolated).

2.3 Dimension drawing

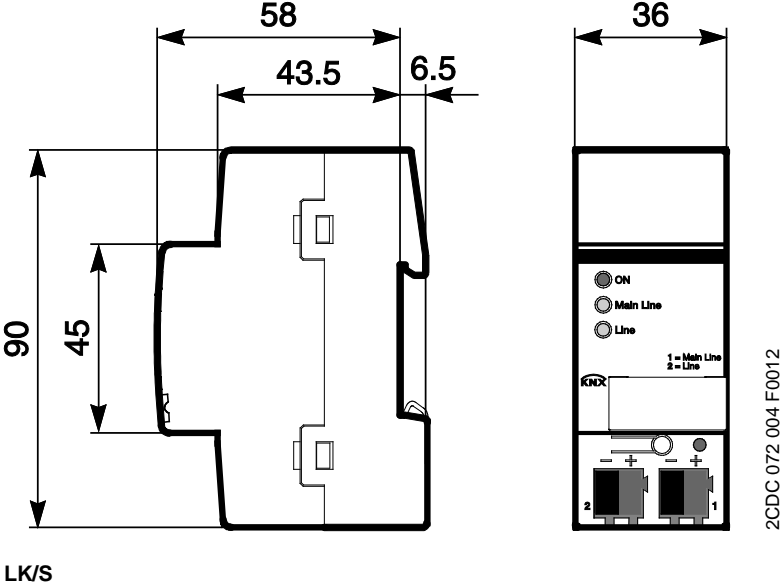

### 2.4 Assembly and installation

The LK/S is a modular installation device for quick installation in the distribution board on 35 mm mounting rails to EN 60 715.

The LK/S mounting position can be selected as required.

The connection to the bus is established using the supplied bus connection terminals.

Accessibility to the LK/S for the purpose of operation, testing, visual inspection, maintenance and repair must be provided compliant to VDE 0100-520.

#### Commissioning requirements

In order to commission the LK/S, a PC with ETS and a KNX interface, e.g. USB or IP, are required. The LK/S is ready for operation, after bus voltage is connected to the main line.

For programming the Line Coupler, it is necessary to at least connect the primary line. If the secondary subline is also connected, the LK/S can also be programmed from the secondary subline.

The installation and commissioning may only be carried out by electrical specialists. The appropriate norms, guidelines, regulations and specifications for your country should be observed when planning and setting up electrical installations and security systems for intrusion and fire detection.

Protect the device from damp, dirt and damage during transport, storage and operation.

Only operate the device within the specified technical data limits!



The device should only be operated in an enclosed housing (distribution board)!

#### Supplied state

The LK/S is supplied with the physical address 15.15.0.

#### Assignment of the physical address

The assignment and programming of the physical address is carried out in the ETS.

Button  on the LK/S is pressed to assign the physical address. The red LED  lights up. It switches off, as soon as the ETS has assigned the physical address or button  has been pressed again. The selection of the physical address is dependent on the required device function (coupler or repeater).

For further information see: [Product and functional overview](#), page 5.

#### Cleaning

If devices become dirty, they can be cleaned using a dry cloth or a cloth dampened with a soapy solution. Corrosive agents or solutions should never be used.

#### Maintenance



The LK/S is maintenance-free. No repairs should be carried out by unauthorised personnel if damage occurs, e.g. during transport and/or storage.



## 2.4.1 Display elements

Indicator LEDs are located on the front of the LK/S.

The response of the display elements is described in the following table:

LED	KNX operation
 <b>ON</b>	<i>OFF</i> : The LK/S is not operational. No power supply is applied or it has malfunctioned. <i>ON</i> : The LK/S is operational and is supplied by the main line. The power supply is applied.
 <b>Main Line</b>	<i>OFF</i> : No main line connected or voltage failure on the main line. <i>ON</i> : The main line is connected. <i>Flashes</i> : Telegram traffic on the main line.
 <b>Line</b>	<i>OFF</i> : No line connected or voltage failure on the line. <i>ON</i> : A line is connected. <i>Flashes</i> : Telegram traffic on the line.



## 3 Commissioning

The parameterization of the LK/S is undertaken using application program *Couple Repeat/2*, *Couple/1* or *Repeat/1* and the Engineering Tool Software ETS.

The application program can be found at *ABB/System devices/Couplers*.

For parameterization purposes, a PC or Laptop with ETS and a connection to the KNX, e.g. via RS232, USB or IP interface, is required.

### 3.1 Overview

The following table provides an overview of the functions possible with the LK/S 4.2 and the application programs *Couple Repeat 2.x* (ETS 4) as well as *Couple/1.x* or *Repeat/1.x* (ETS 3).

<i>Line/Area Coupler</i> properties	ETS 3	ETS 4
Function <i>Line/Area Coupler</i>	■	■
Filter group telegrams main group 0...13	■	■
Filter group telegrams main group 14...31		■
Block physically addressed telegrams		■
Block broadcast telegrams		■
In case of errors repeat telegrams	■	■
Telegram confirmation	■	■

■ = property applies

<i>Repeater</i> properties	ETS 3	ETS 4
Function <i>Repeater</i>	■	■
In case of errors repeat telegrams	■	■

■ = property applies

## 3.2 Parameters

The parameterization of the LK/S is implemented using the Engineering Tool Software ETS.

The application program can be found in the ETS at *ABB/System devices/Couplers*.

The following chapter describes the parameters of the LK/S using the parameter windows. The parameter windows feature a dynamic structure, so that further parameters may be enabled depending on the parameterization and the function.

The default values of the parameters are underlined,

e.g.:

Options:     yes  
              no

### 3.2.1 Application for ETS 4

The application *Couple Repeat/2.x* with extended functional range is only available for the LK/S 4.2 and ETS 4.1.2 or higher.

# ABB i-bus<sup>®</sup> KNX Commissioning

## 3.2.1.1 Parameter window *General*

The device functions are defined in this parameter window.

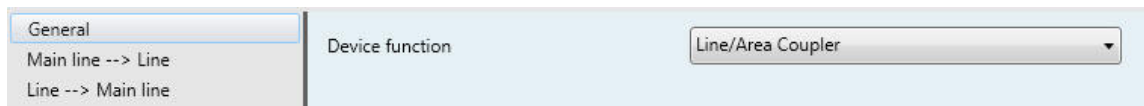

### Device function

Options:     Line/Area Coupler  
              Repeater

- *Line/Area Coupler*: The data flow between two lines is connected. Both lines are electrically isolated from one another. The Parameter window [Main line --> Line](#), page 20, and Parameter window [Line --> Main line](#), page 23, appear.
- *Repeater*: The data flow between two line segments is connected. Both lines are electrically isolated from one another. Parameter window [Settings](#), page 24, is enabled.

## 3.2.1.2 Device function - *Line/Area Coupler*

### 3.2.1.2.1 Parameter window *Main line --> Line*

This parameter window is visible if in Parameter window [General](#), page 19, the device function *Line/Area Coupler* has been selected.

In this parameter window, the settings for the connection from the primary/main line to the line are undertaken.

General	Group telegrams main group 0...13	filter
<b>Main line --&gt; Line</b>	Group telegrams main group 14...31	filter
Line --> Main line	Physically addressed telegrams	filter
	Broadcast telegrams	route
	In case of errors repeat telegrams	yes
	Telegram confirmation	only if routed
	If free group address structure is used:	<-- Note
	Main group 0...13 => 1...28,671	
	Main group 14...31 => 28,672...65,535	

#### Group telegrams main group 0...13

#### Group telegrams main group 14...31

Option: filter  
route  
block

- *filter*: Only group telegrams entered into the filter table are routed. The ETS automatically creates the filter table.
- *route*: All group telegrams are routed.
- *Block*: All group telegrams are blocked.

#### Physically addressed telegrams

Option: filter  
block

- *filter*: Physically addressed telegrams (programming telegrams) are routed according to the topology.
- *block*: Physically addressed telegrams are blocked.

# ABB i-bus<sup>®</sup> KNX Commissioning

## Broadcast telegrams

Options: route  
block

Broadcast telegrams are used, for example, by the ETS to identify KNX devices in programming mode.

- *route*: Broadcast telegrams are routed.
- *Block*: Broadcast telegrams are blocked.

## In case of errors repeat telegrams

Options: yes  
no  
user-defined

- *yes*: If an error is detected when a telegram is transmitted, the telegram is repeated up to three times.
- *no*: The telegram is not repeated.
- *user-defined*: The response can be set individually for different types of telegram.

## Repeat group addressed telegrams

Options: yes  
no

- *yes*: If an error is detected when a group addressed telegram is transmitted, the telegram is repeated up to three times.
- *no*: The telegram is not repeated.

## Repeat physically addressed telegrams

Options: yes  
no

- *yes*: If an error is detected when a physically addressed telegram is transmitted, the telegram is repeated up to three times.
- *no*: The telegram is not repeated.

## Repeat broadcast telegrams

Options: yes  
no

- *yes*: If an error is detected when a broadcast telegram is transmitted, the telegram is repeated up to three times.
- *no*: The telegram is not repeated.

# ABB i-bus<sup>®</sup> KNX Commissioning

## Telegram confirmation

Options:      only if routed  
                 always

- *only if routed*: Telegrams that are routed are acknowledged.
- *always*: Every telegram is acknowledged.

**The following applies with a group address view:**

**Main groups 0...13 => 1...28,671**

**Main groups 14...31 => 28,672...65,535**

<---NOTE

In the ETS 4 it is possible to not just assign two or three-stage group addresses, it is possible to freely assign them. If the free group address view is selected, main group 0...13 corresponds to subgroup range 1...28,671 and main group 14...31 with subgroup range 28,672...65,535. Relevant details can be read with the assistance of the Help in the ETS.



# ABB i-bus<sup>®</sup> KNX Commissioning

## 3.2.1.2.2 Parameter window *Line --> Main line*

This parameter window is visible if in Parameter window [General](#), page 19, the device function *Line/Area Coupler* has been selected.

In this parameter window, the telegram functions for the connection from a secondary line to the primary/main line are defined.

The parameter setting of the connections *Line --> Main line* and *Main line --> Line* do not differentiate from one another. The descriptions of the parameter setting options are described in Parameter window [Main line --> Line](#), page 20.

## 3.2.1.3 Device function *Repeater*

### 3.2.1.3.1 Parameter window *Settings*

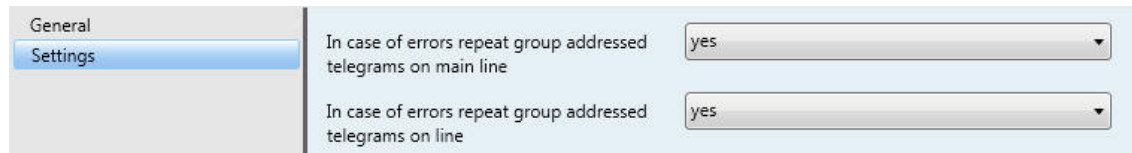

This parameter window is visible if in Parameter window [General](#), page 19, the device function *Repeater* has been selected.

#### **In case of errors repeat group addressed telegrams on main line**

Options:     yes  
              no

- *yes*: If an error is detected when a group addressed telegram is transmitted on the main line, the telegram is repeated up to three times.
- *no*: The telegram is not repeated.

#### **In case of errors repeat group addressed telegrams on line**

Options:     yes  
              no

- *yes*: If an error is detected when a group addressed telegram is transmitted on a line, the telegram is repeated up to three times.
- *no*: The telegram is not repeated.

# ABB i-bus<sup>®</sup> KNX Commissioning

## 3.2.2 Applications for the ETS 3

The applications *Couple/1.x* and *Repeat/1.x* can be loaded in the LK/S 4.2 via the ETS 3.

### 3.2.2.1 Application *Couple/1.x*, parameter window *Settings*

In this parameter window, the settings for the Area/Line Coupler are defined.

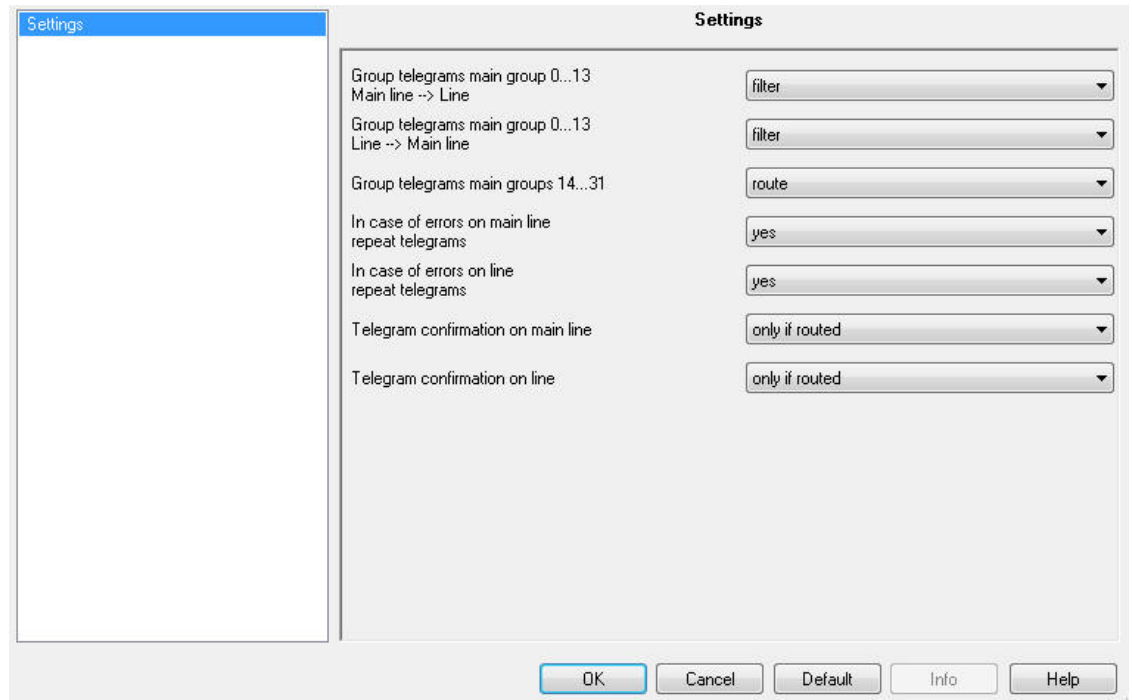

#### Group telegrams main group 0...13 Main line --> Line

#### Group telegrams main group 0...13 Line --> Main line

Option: filter  
route  
block

- *filter*: Only group telegrams entered into the filter table are routed. The ETS automatically creates the filter table.
- *route*: All group telegrams are routed.
- *Block*: All group telegrams are blocked.

# ABB i-bus<sup>®</sup> KNX Commissioning

## Group telegrams main group 14...31

Options:     route  
              block

- *route*: All group telegrams are routed.
- *Block*: All group telegrams are blocked.

## In case of errors repeat group addressed telegrams on main line

### In case of errors repeat group addressed telegrams on line

Options:     yes  
              no

- *yes*: If an error is detected when a telegram is transmitted, the telegram is repeated up to three times.
- *no*: The telegram is not repeated.

## Telegram confirmation on Main Line

### Telegram confirmation on Line

Options:     only if routed  
              always

- *only if routed*: Telegrams that are routed are acknowledged.
- *always*: All telegrams are acknowledged.

# ABB i-bus<sup>®</sup> KNX Commissioning

## 3.2.2.2 Application *Repeat/1x*

### 3.2.2.2.1 Parameter window *Settings*

In this parameter window, the settings for the function *Repeater* are undertaken.

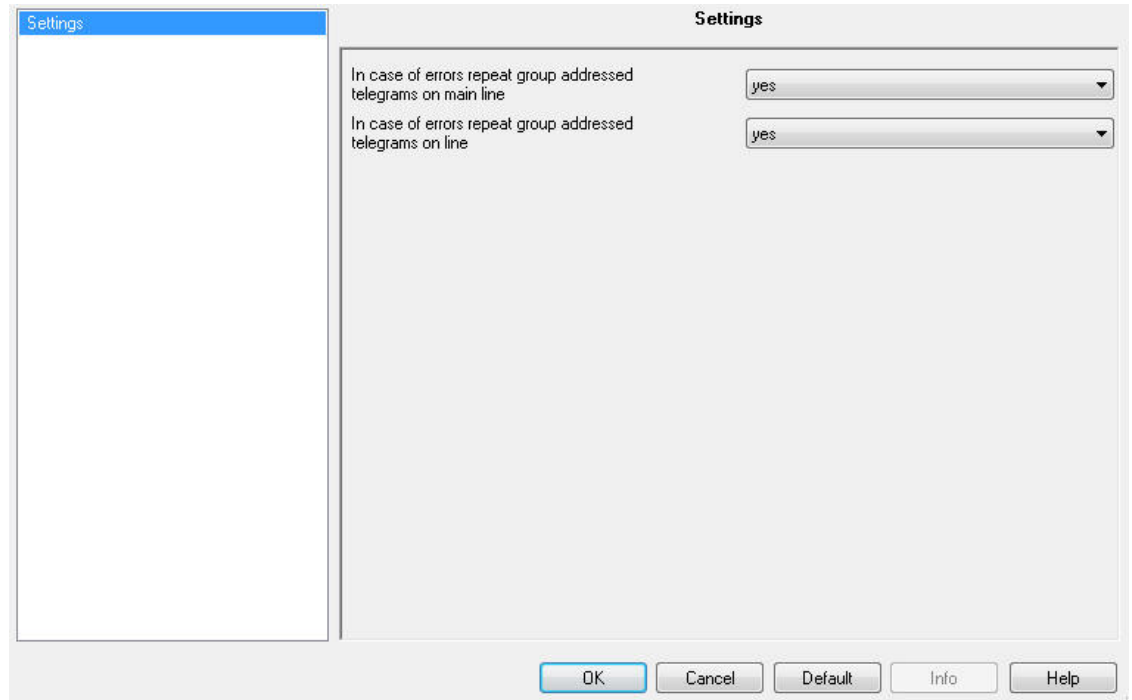

#### **In case of errors repeat group addressed telegrams on main line**

Options:    yes  
              no

- *yes*: If an error is detected when a group addressed telegram is transmitted on the main line, the telegram is repeated up to three times.
- *no*: The telegram is not repeated.

#### **In case of errors repeat group addressed telegrams on line**

Options:    yes  
              no

- *yes*: If an error is detected when a group addressed telegram is transmitted on a line, the telegram is repeated up to three times.
- *no*: The telegram is not repeated.



## **A**            **Appendix**

### **A.1**            **Scope of delivery**

The ABB i-bus<sup>®</sup> KNX Line Coupler LK/S 4.2 is supplied together with the following components.  
Please check the items received using the following list.

- 1 x LK/S 4.2, MDRC
- 1 x installation and operating instructions
- 2 x bus connection terminal (red/black)

## A.2 Ordering information

Device type	Product name	Order No.	bbn 40 16779 EAN	Price group	Weight 1 pc. [kg]	Pack unit [pc.]
LK/S 4.2	Line Coupler, MDRC	2CDG 110 171 R0011	88167 8	P2	0.075	1



# ABB i-bus<sup>®</sup> KNX Appendix

## A.3 Notes

**Notes**



# Contact

## **ABB STOTZ-KONTAKT GmbH**

Eppelheimer Straße 82

69123 Heidelberg, Germany

Phone: +49 (0)6221 701 607

Fax: +49 (0)6221 701 724

e-mail: [knx.marketing@de.abb.com](mailto:knx.marketing@de.abb.com)

## **Further information and local contacts:**

**[www.abb.com/knx](http://www.abb.com/knx)**

## **Note:**

We reserve the right to make technical changes to the products as well as amendments to the content of this document at any time without advance notice.

The agreed properties are definitive for any orders placed. ABB AG shall not be liable for any consequences arising from errors or incomplete information in this document.

We reserve the rights to this document and all the items and illustrations contained therein. Reproduction, transfer to third parties or processing of the content – including sections thereof – is not permitted without prior expressed written permission from ABB AG.

Copyright© 2012 ABB

All rights reserved